



gemini
ITALY

8L Mini Electric Oven
8L 迷你電焗爐
Model No. 型號: GOV8P
700W



Before using your product for first time, please read this instruction manual.
在使用本產品前，請仔細閱讀本說明書並保存好。

IMPORTANT SAFEGUARDS

1. When using this electric oven, basic precautions should always be followed, included the followings:
2. Read all instructions.
3. Do not touch hot surface, use handles and knobs.
4. Close supervision is necessary when any appliance is used by or near children.
5. To protect against electric shock, do not immerse cord, plug or any parts of the oven in water or other liquids.
6. Do not let cord hang over edge of table or counter, or touch hot surface.
7. Do not operate appliances with damaged cord or plug or after the appliance malfunctions, or have been damaged in any manner. Return the appliance to the nearest authorized service center of examination, repair, or adjustment.
8. Do not use mismatched accessory, it may cause hazard or injury.
9. Do not place on or near a hot gas or electric burner, or in a heated oven or in a microware oven.
10. When operating the oven keep at least 4 inches of space on all sides of the oven to allow for adequate air circulation.
11. Unplug from outlet when not in use and before cleaning. Allow to cool before putting on or taking off parts, and before cleaning.
12. To disconnect, turn the time control to OFF, then remove the plug. Always hold the plug, but never pull the cord.
13. Extreme cautions must be used when moving an appliance containing hot oil or other hot liquid.
14. Do not use metal to touch any part of oven when operating.
15. Be extreme cautions when remove the tray or disposing of hot grease or other hot liquid.
16. Do not clean with metal scouring pads pieces can break off the pad and touch electric parts, creating a risk of electric shock.
17. Never leave the appliances unattended while broiling or toasting.
18. Oversized foods and metal utensils must not be inserted in the oven as they may create a fire or risk of electric shock.
19. A fire may cause if oven is covered or touching inflammable material, including curtains draperies, walls and like, when on operation, Do not store any item on the oven during operation.
20. Extreme caution should be exercised when using containers constructed of anything other than metal or glass.
21. Do not place any of the following materials on the oven: cardboard, plastic, paper or anything similar.
22. Do not store any materials, other than recommended accessories in the oven.
23. Always wear protective, insulated oven gloves when inserting or removing any items from the hot oven.
24. This appliance is for household use only, do not use outdoor.
25. Do not use appliance for other than intended use.
26. This appliance can be used by children aged from 8 years and above and persons with reduced physical, sensory or mental capabilities or lack of experience and knowledge if they have been given supervision or instruction concerning use of the appliance in a safe way and understand the hazards involved.
27. Children shall not play with the appliance. Cleaning and user maintenance shall not be made by children without supervised.
28. If the supply cord is damaged, it must be replaced by the After-sales Service Center or a similarly qualified person in order to avoid a hazard.

PARTS OF APPLIANCE

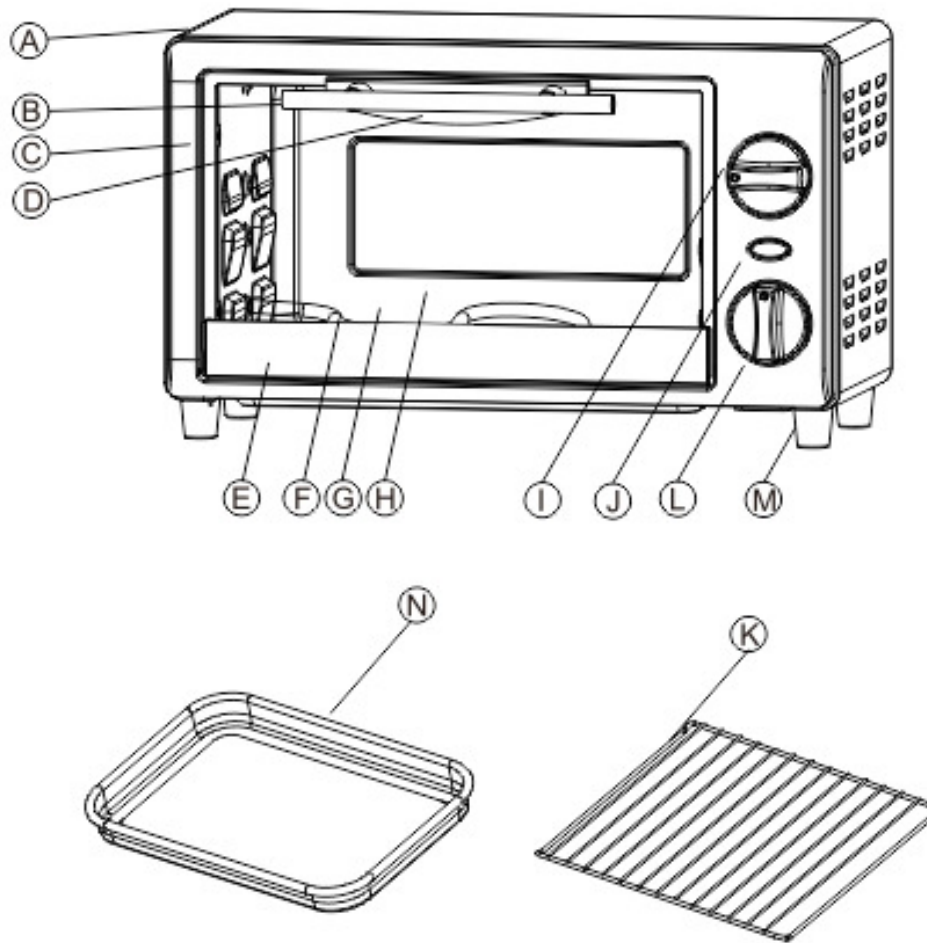

A. Housing

B. Door handle

C. Front plate

D. Upper door clip

E. Lower door clip

F. 'S' Shape heating element

G. Glass door

H. Back board

I. Temperature control knob

J. Power indicator light

K. Wire rack

L. Timer knob

M. Foot

N. Bake tray

OPERATING INSTRUCTION

Before using your oven for the first time

Be sure to

1. Make sure that the oven is unplugged and the **TIMER** switch is on the **OFF** position.
2. Remove all rack and pans and wash them in hot sudsy water or in the dishwasher.
3. Thoroughly dry all accessories and re-assemble in oven. Plug the power cord into socket and you are ready to use your new oven.
4. After re-assembling your oven, we recommend that you run in at the max temperature for approximately 15 minutes to eliminate any dirty oil on its surface.
5. The oven may emit smoke with first time use under normal operating conditions and will soon disappear after 5 minute.

HOW TO USE YOUR OVEN FOR BAKING AND GRILLING

1. Put the power plug in the socket

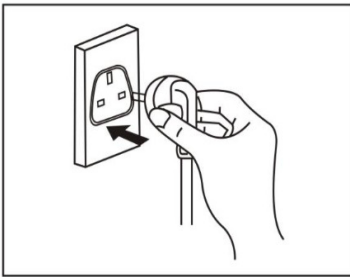

2. Pre-heat the oven with approximate 15 minutes

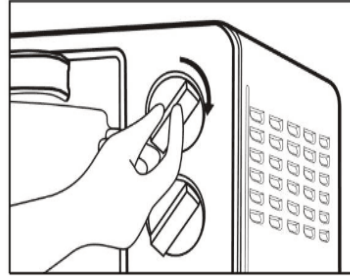

3. Put the food into oven

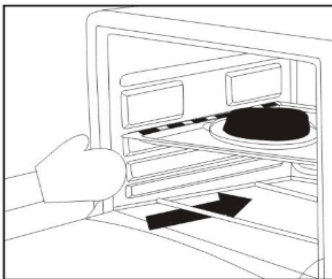

4. Set the temperature and time

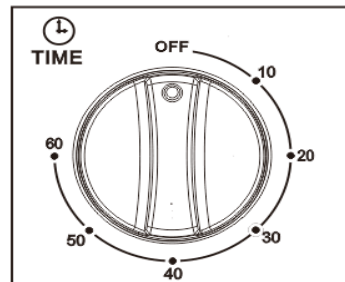

5. Take out the food when the process finished

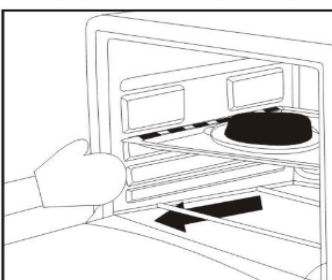

6. Unplug the power

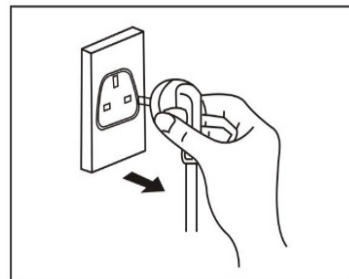

CLEANING

- 1. It is important that you clean the appliance after each use to prevent an accumulation of grease and avoid unpleasant odors.**
- 2. The appliance must be cool down and unplug from outlet before cleaning.**
- 3. Do not immerse appliance in water or wash it under waterspout.**
- 4. Removable wire rack and bake tray can be washed, as normal kitchen ware.**
- 5. Clean outer surface of appliance with damp cloth.**
- 6. Do not use abrasive cleaner or sharp utensils to clean the oven, as scratching may weaker it and cause shattering,**
- 7. Let all parts and surfaces dry thoroughly prior to plugging oven in the socket.**

SPECIFICATION

Model No. : GOV8P

Power: 700 W

Voltage: 220V~50Hz

Capacity: 8L

Product dimension: 350(W) x 206(H) x 230(D) mm

安全注意事項

1. 在使用本產品前，請遵循以下基本安全措施。
2. 仔細閱讀本使用說明書。
3. 在使用時焗爐時，不允許小孩子操作或接近焗爐。
4. 為防止觸電，嚴禁將電源線，插頭或電焗爐的任何部件浸入水中。
5. 電源線不能接觸焗爐的受熱面。
6. 不要讓電源線懸掛在桌子或櫃檯邊緣或接觸發熱表面。
7. 電源線、插頭、附件損壞或電器設備出現故障的情況下，為避免危險切勿操作電器，請聯繫指定的專職維修人員進行更換檢查。
8. 不要使用不建議使用的配件，以免發生危險及造成傷害。
9. 不要將焗爐放在靠近熱水器，電爐或微波爐等熱源的地方。
10. 在使用焗爐時，要保證焗爐每一邊至少有 4 英寸的空間，讓空氣流通。
11. 當不使用焗爐或清潔時，請先拔掉電源線插頭，要先冷卻才能進行拆卸配件。
12. 斷開連接時，將定時器旋鈕調到“OFF”處，然後拔下電源插頭，拔下插頭時，請務必抓住插頭，不要拉扯電源線。
13. 移動裝有熱油或其他高溫液體的器具時，必須格外小心。
14. 不要用金屬片去接觸焗爐的任何部件。
15. 移動托盤或處置熱油脂或其他高溫液體時要格外小心。
16. 焗爐在使用時，不要使用帶金屬的刷子去清潔，因可能與帶電部件接觸，造成危險。
17. 當焗爐在使用時，請注意有人看管。
18. 體積較大的食物或玻璃，塑料類的器皿切勿放入焗爐內烘烤，以免危險。
19. 焗爐頂部不得盛放任何物品或覆蓋易燃物品（如窗簾，牆紙等），容易釀成火災。
20. 使用一些由金屬或玻璃製成的容器時要格外小心。
21. 請勿將紙板，塑料，紙等類似易燃物品放在焗爐內加熱。
22. 不要將除配置推薦外的配件放入焗爐內。
23. 從焗爐內插入或取出物品時，一定要帶上防護套。
24. 本產品只可作家庭用途，不能放置戶外使用。
25. 不可讓本產品作非指定用途使用。
26. 該電器可適用於 8 歲以上的兒童以及身體，感官或者智力能力下降和缺乏經驗和知識的人群，他們使用該電器需要得到安全使用電器的監督或者指導，並且了解所涉及的危險。
27. 成人應該指導小孩不可把玩此電器。
28. 定期檢查本產品的電源線。如果電源線損壞，必須由本公司售後服務部或合格的電器技師更換，以避免危險。

產品部件

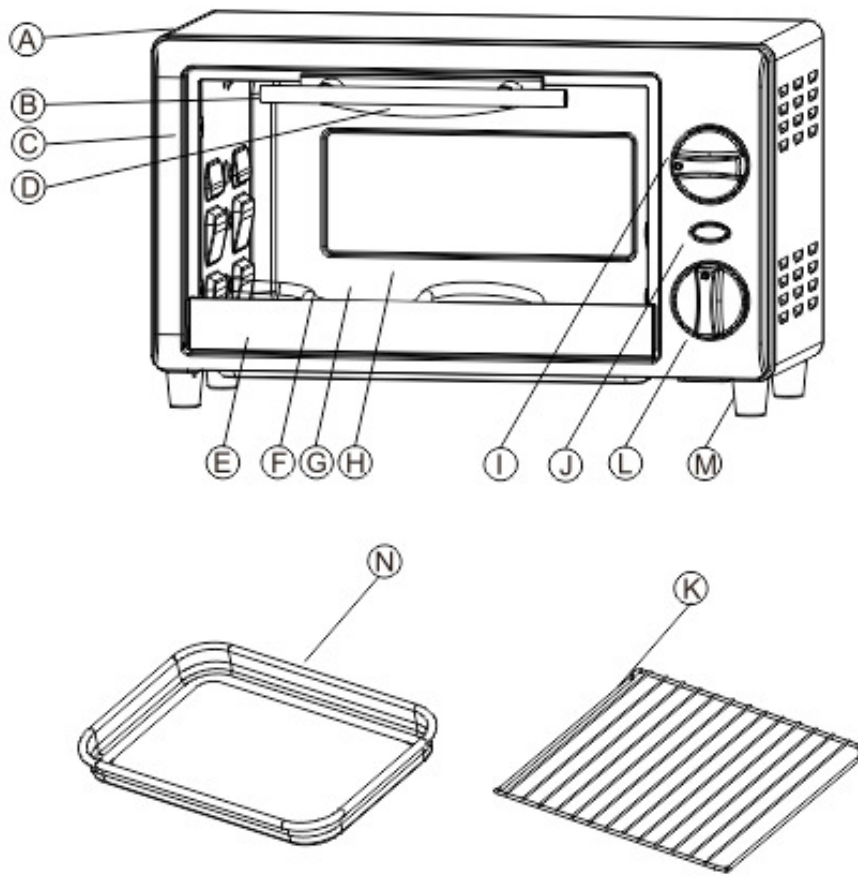

- A. 機身
- B. 門把拉手
- C. 前門板
- D. 上門夾
- E. 下門夾
- F. 'S'型不銹鋼發熱管
- G. 玻璃門

- H. 後板
- I. 溫度設定旋鈕
- J. 電源指示燈
- K. 烤網
- L. 定時器旋鈕
- M. 爐腳
- N. 烤盤

操作指南

首次使用

1. 初次使用焗爐前，將定時器旋鈕至於 OFF 位置。
2. 打開玻璃門，把所有部件清理乾淨及待本機完全冷卻才進行清潔。
3. 將所有部件放進焗爐裏組裝好，然後接駁電源，即可以使用。
4. 裝好部件後，建議把溫度旋鈕調到最大，預熱 15 分鐘左右，這樣可以消除殘留的油脂。
5. 第一次使用焗爐時有黑煙冒出是正常現象，大約五分鐘後會逐漸消失。

烘烤功能的使用方法

1. 插上電源

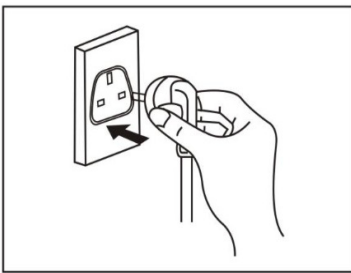

2. 焗爐預熱約 15 分鐘

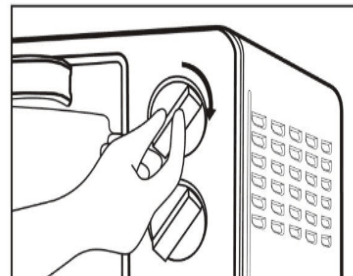

3. 放入食物開始烘烤

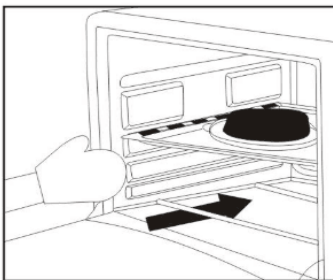

4. 設置好時間和溫度

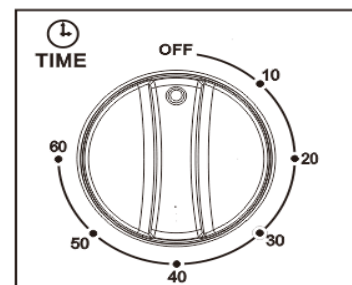

5. 結束烘烤，取出食物

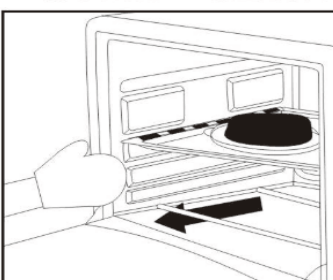

6. 拔下插頭

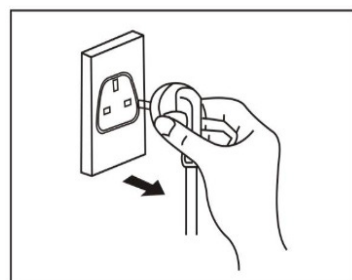

清潔及維護保養

1. 每次使用後，要清潔烤箱所有部件，以防止油脂積聚和避免留下烘烤味。
2. 清潔焗爐之前，請拔下電源插頭。
3. 不要將焗爐浸在水裡及在水龍頭下清洗。
4. 可以拆卸烤盤和烤網清洗。
5. 清潔表面需用柔軟的濕布輕輕擦拭。
6. 不要使用研磨清潔劑或尖銳的器具清潔焗爐。
7. 每次使用焗爐前要先讓所有部件及焗爐表面保持乾爽

技術規格

產品型號: GOV8P

額定功率: 700W

電壓頻率: 220V~50Hz

焗爐容量: 8L

產品尺寸: 350(闊) x 206(高) x 230(深) 毫米

請記錄下列產品資料

- 型號 _____
- 機身號碼 _____
- 經銷商名稱 _____
- 購買日期 _____

本產品不斷改進中，如功能有所更改，恕不另行通知，如有疑問，請於客戶服務中心聯繫，不便之處，敬請原諒。

說明書內容以英文版本為準。

ToolBox Customer Service Center 客戶服務中心

7/F., Goodwill Industrial Building, 36-44 Pak Tin Par Street, Tsuen Wan, N.T.

新界荃灣白田壩街 36-44 號信義工業大廈 7 樓

Customer Service Hotline 客戶服務熱線：(852) 8210 8210

Service Email 電郵地址：8210service@gilman-group.com

Please register now at 請即上網登記：www.toolbox.hk

Website 網址：www.gilman-group.com



Proudly Serviced by

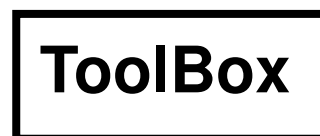

a Gilman Group Company

太平家庭電器

2/F, Shing Dao Industrial Building, 232 Aberdeen Main Road, Hongkong

香港香港仔大道 232 號城都工業大廈 2 樓